



The MEG Experiment at PSI

search for LFV decay $\mu^+ \rightarrow e^+ \gamma$

University of Tokyo

R.Sawada

on behalf of the MEG Collaboration



MEG Experiment



- Start in 2006 at Paul Sherrer Institut (PSI) Switzerland
- The world's most intense DC muon beam. ($>1.8\text{mA} \sim 1 \times 10^8$ muons/sec)
- Collaboration of 11 institutes from 5 countries.

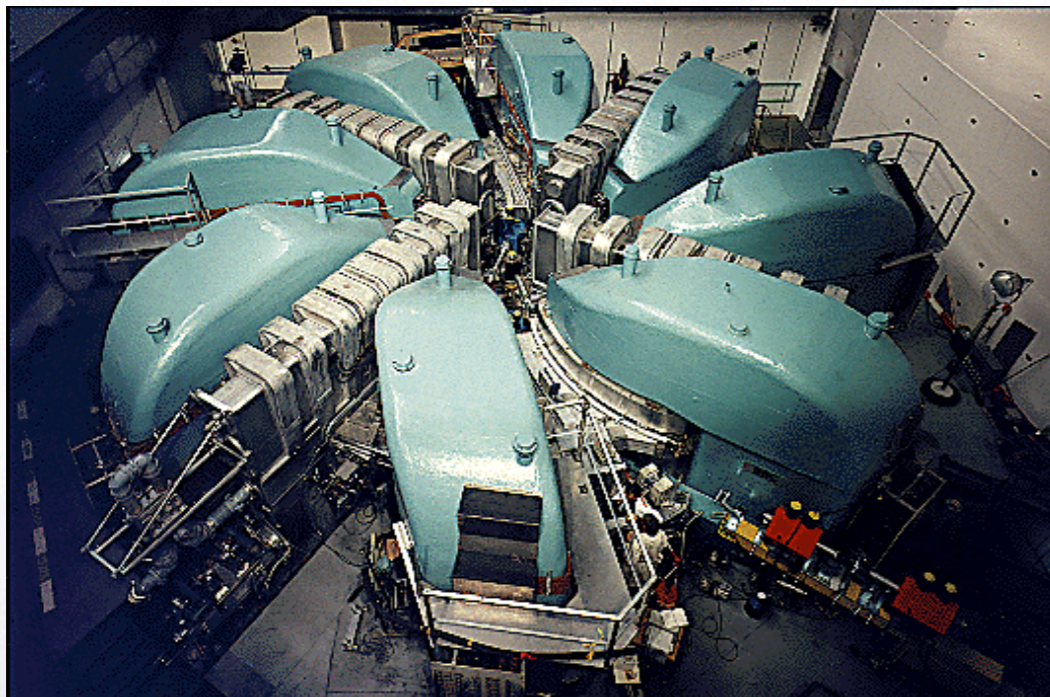



Physics



Standard model predicts unobservable branching ratio ($\sim 10^{-50}$),
while SUSY predicts much larger ratio ($10^{-14} \sim 10^{-12}$)



Discovery of $\mu^+ \rightarrow e^+ \gamma$ is a clear evidence of new physics.

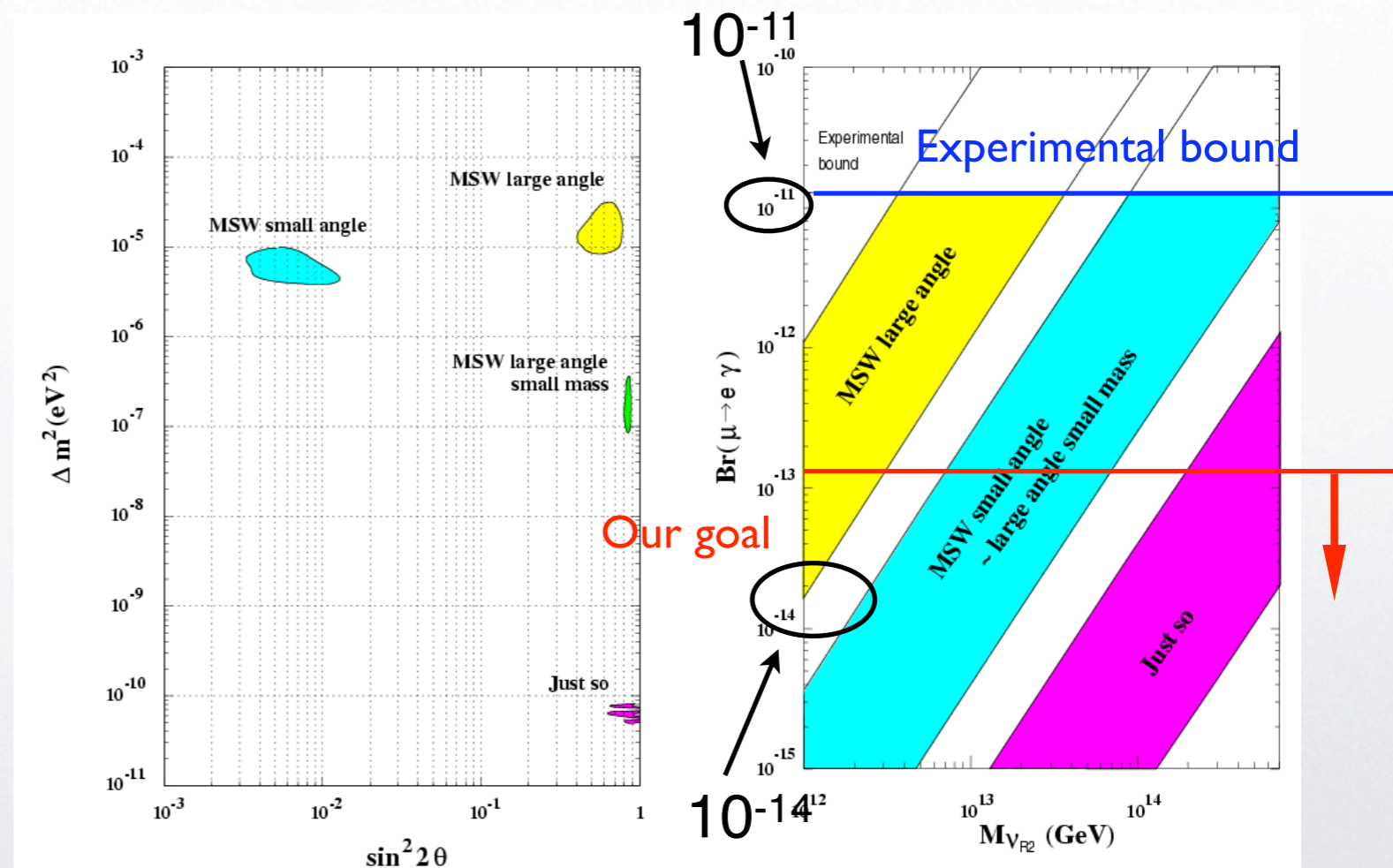
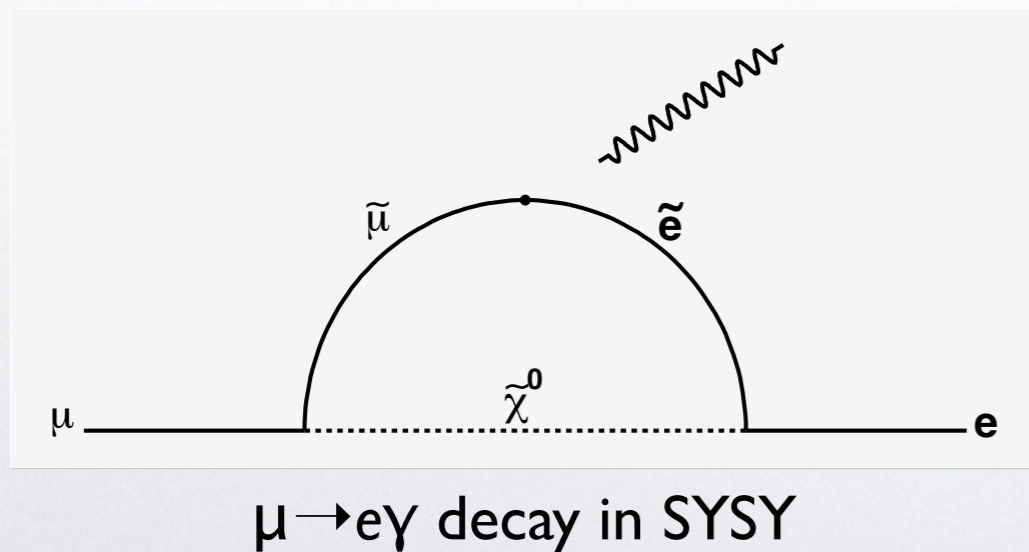



Signal and background



- Signal

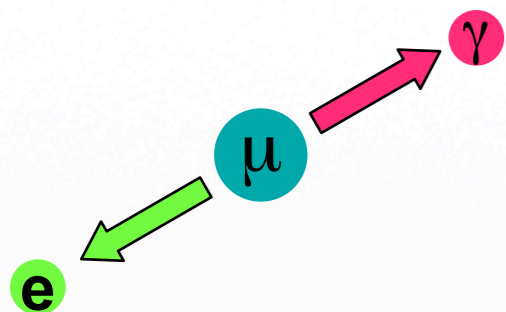

- $E_\gamma = m_\mu/2 = 52.8\text{MeV}$
- $E_e = m_\mu/2 = 52.8\text{MeV}$
- $\theta = 180^\circ$
- Time coincidence

- Background
 - Radiative μ decay

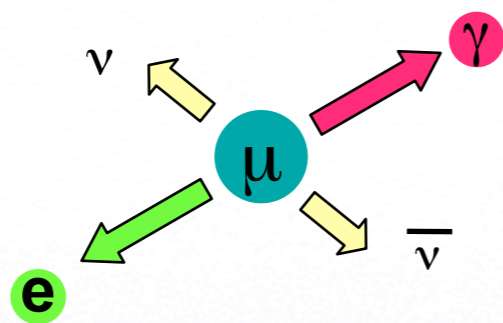

- Accidental overlap

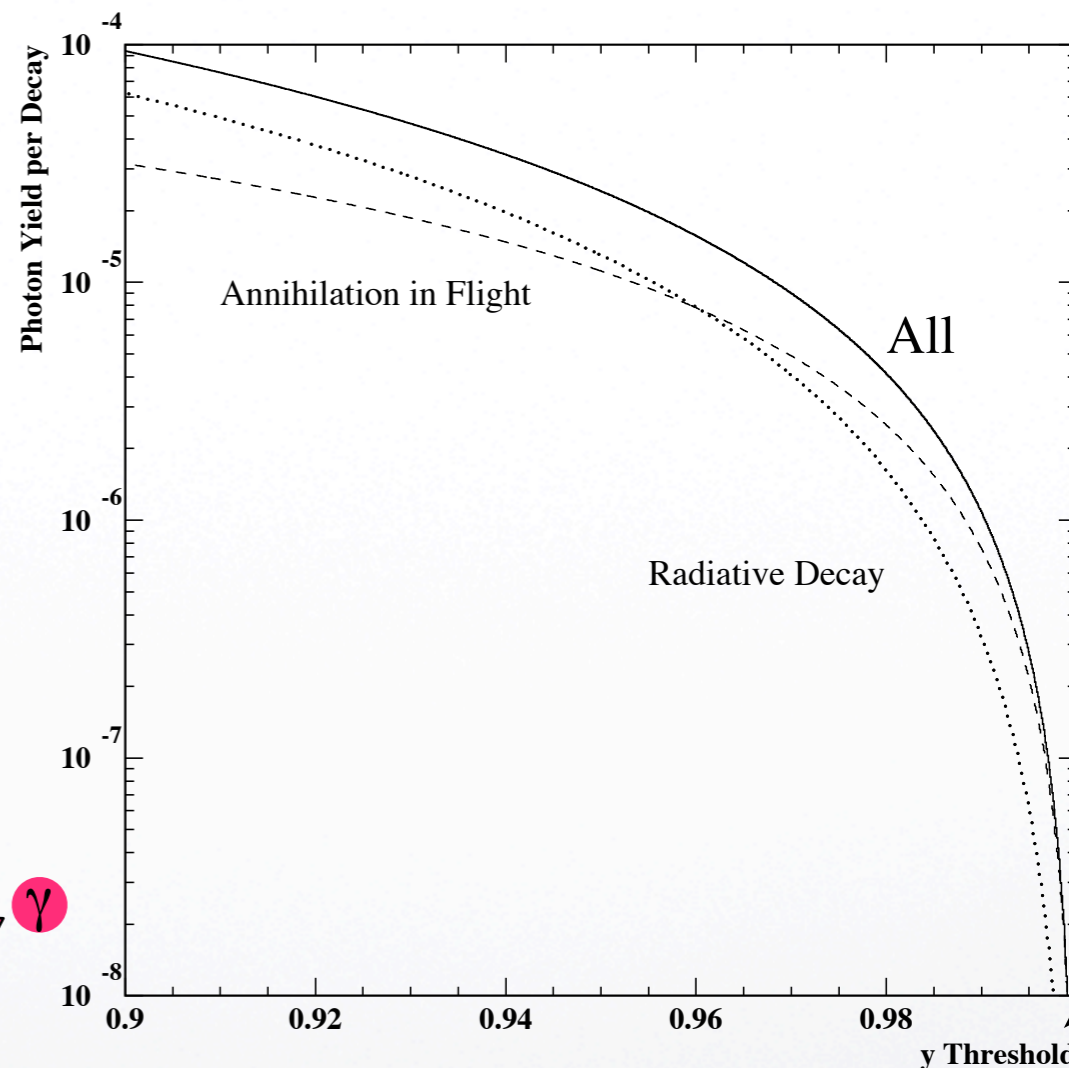
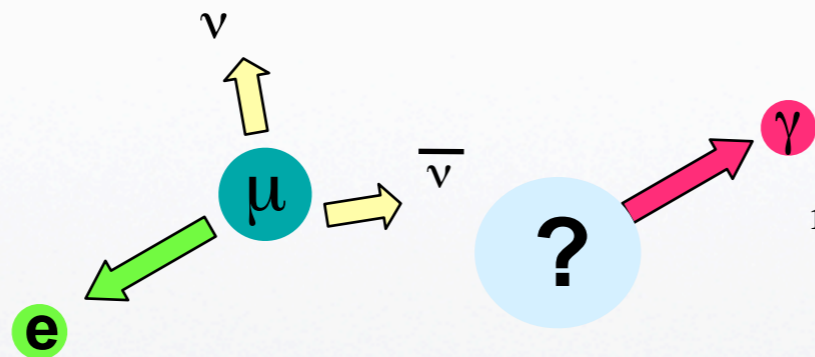

Spectrum of background gamma

52.8 MeV

To reduce background, good resolution of detector is important.



MEG Detector

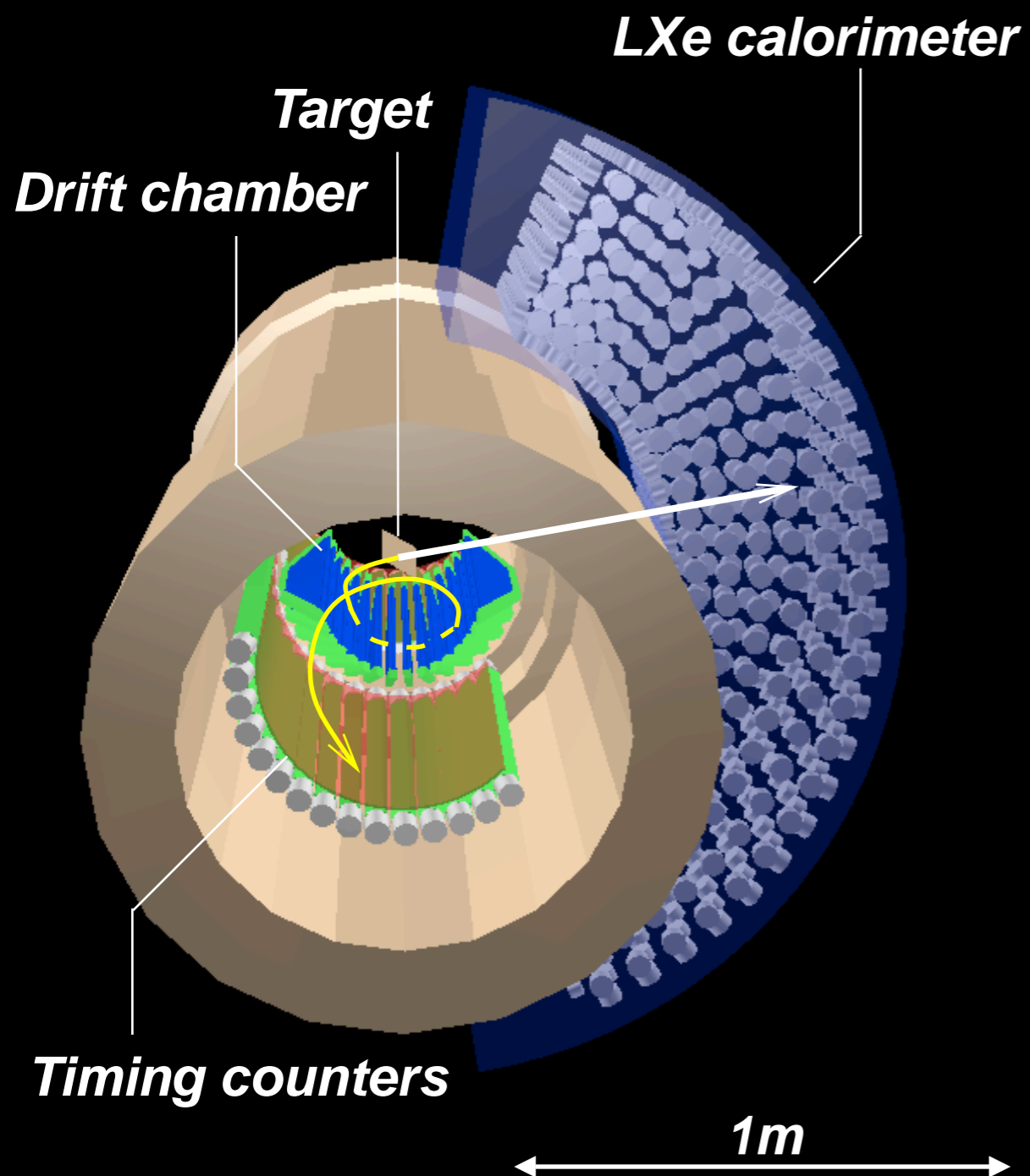

- **Positron detector**

- COBRA magnet
- Drift chamber
- Plastic timing counter

- **Photon detector**

- Liquid Xenon scintillation detector



COBRA Magnet



- COnstant Bending Radius (COBRA) magnet
 - Gradient magnetic field, 1.27 T at $z=0$
 - Sweep out positrons quickly
 - Bending radius is constant for the same energy of positrons. (independent of emission angle)
- Compensation coil to reduce fringe field from main magnet around calorimeter

COBRA

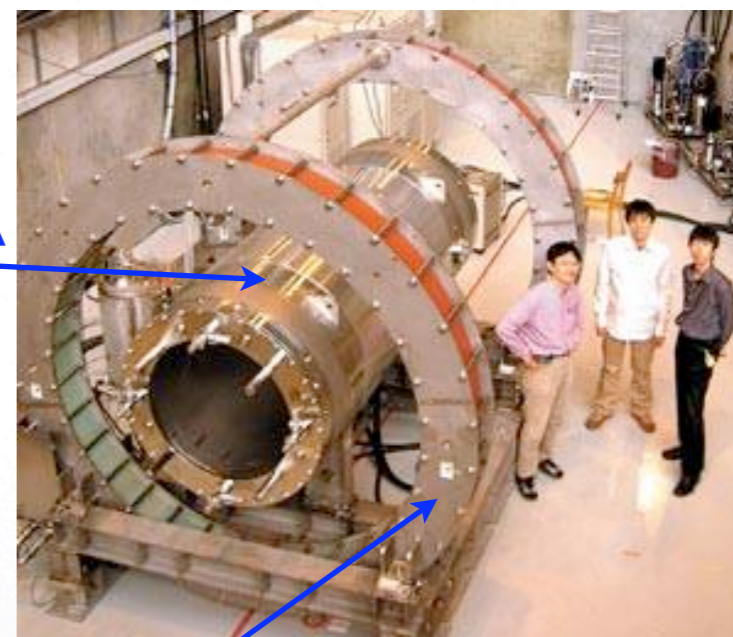

CERN Courier 44 number 6 21-22 2004

Compensation coil

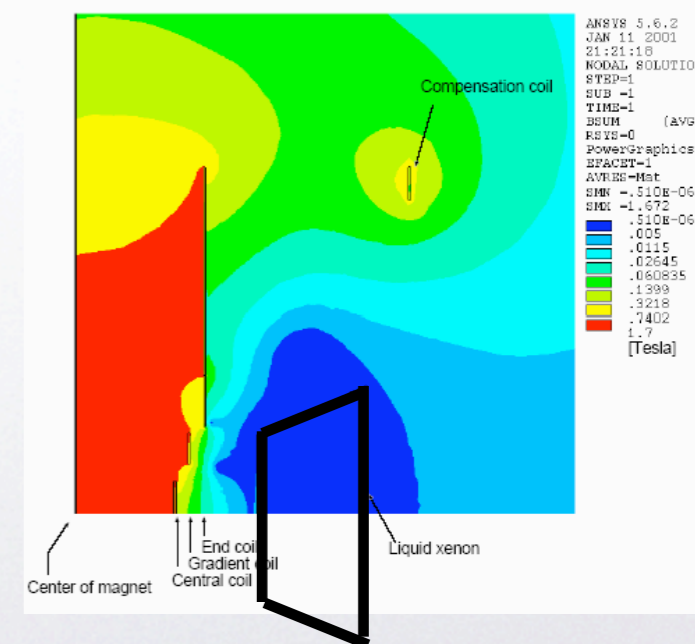
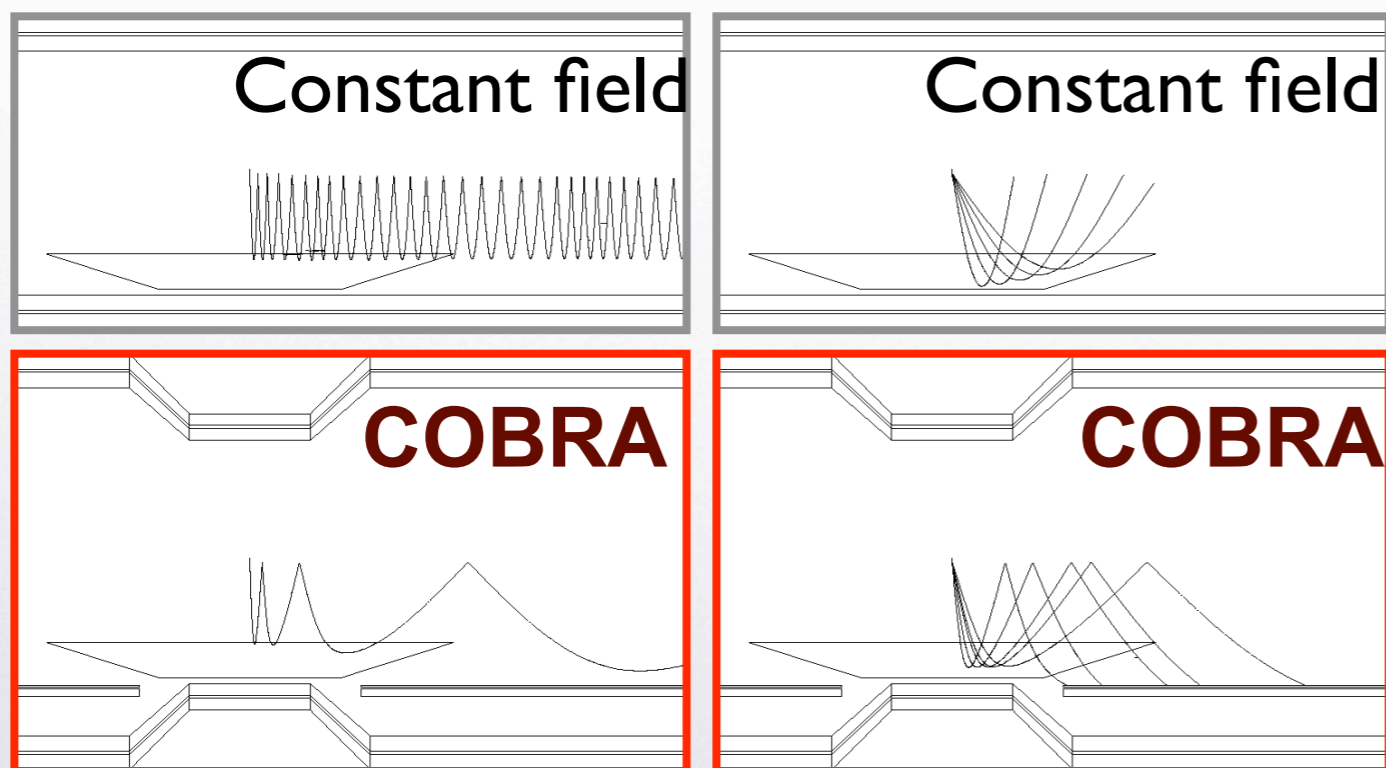

Position of calorimeter (< 50 Gauss)



Drift chamber



- Small amount of material in order to suppress multiple scattering and positron annihilation.
- Cathode with zigzag pattern as vernier to measure precise position along wire.
- Resolution
 - 300 μm hit position resolution for both z and r direction.
 - 0.5 % energy resolution.
 - 1.2 mm accuracy of vertex reconstruction

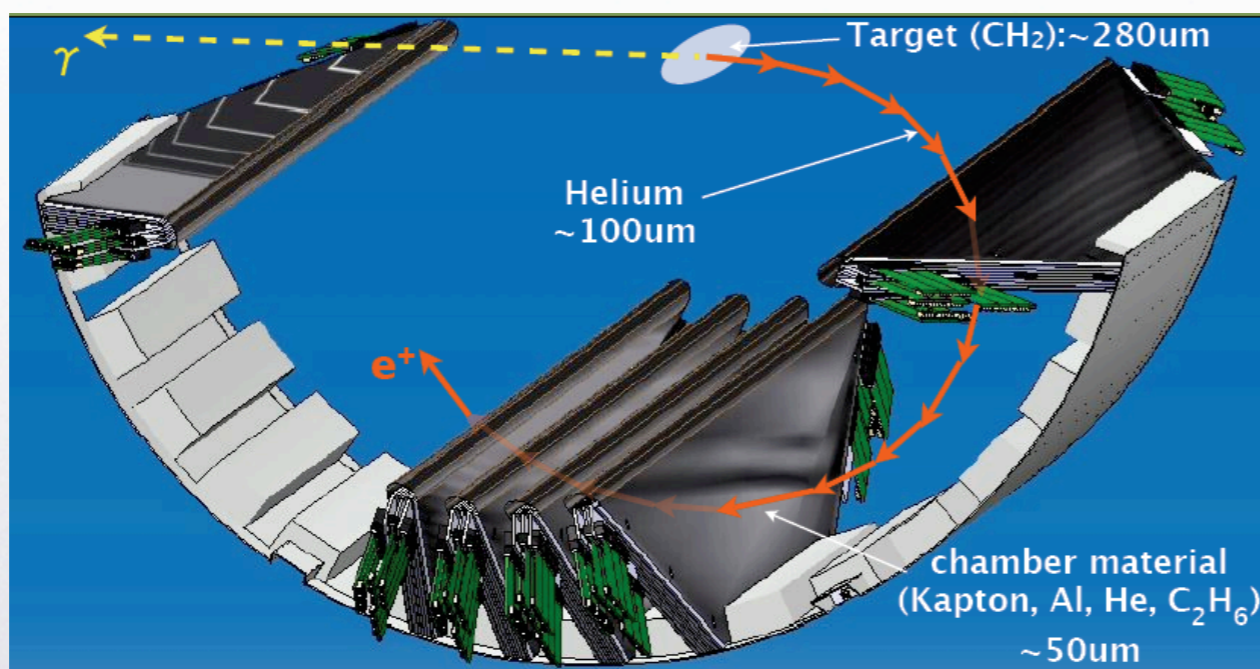



Timing counters

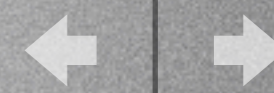

- Scintillator bars for Phi and time measurement
- Scintillation fibers for Z measurement
- Fine mesh PMT and APD to be used in magnetic field

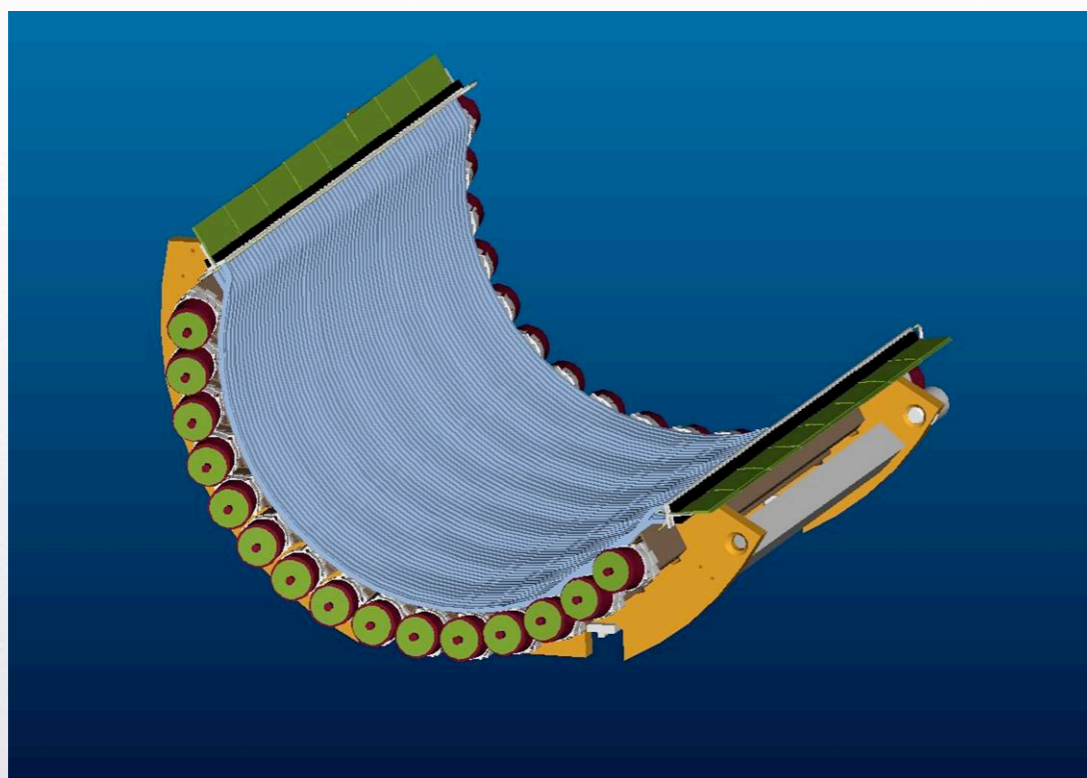

Resolution of one bar was measured in magnetic field

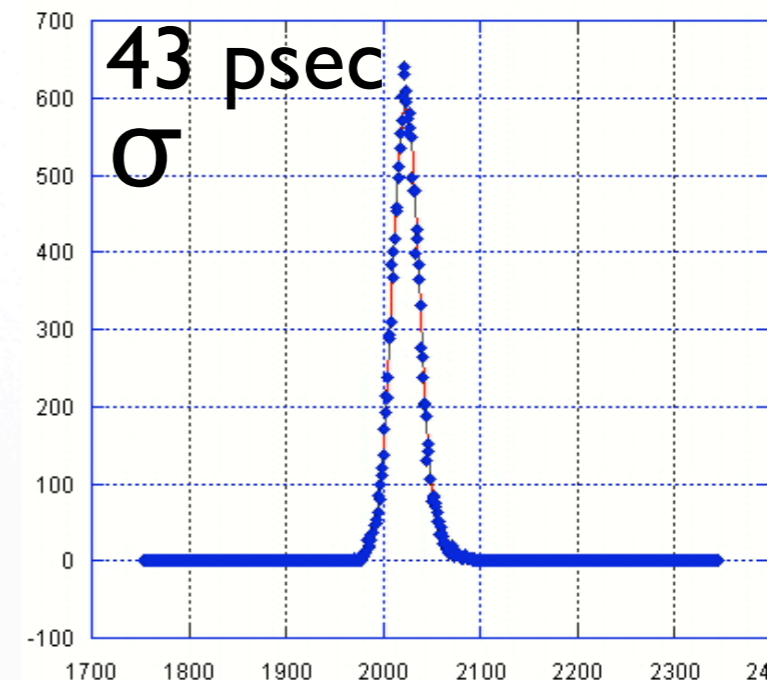

PMTs are tilted for lower field gain suppression.

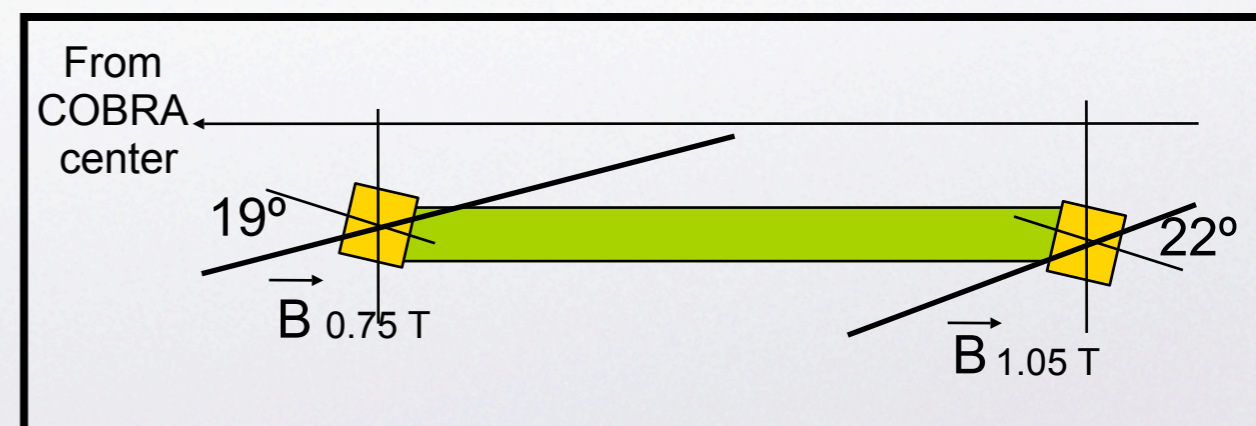

🏠 Liquid Xenon scintillation detector ← | →

- Large amount of light. (comparable to NaI)
 - Good for resolution
- Fast signal
 - Good for time resolution.
 - Less pile up.
- Liquid unsegmented scintillator
 - Possible to measure even r position of conversion

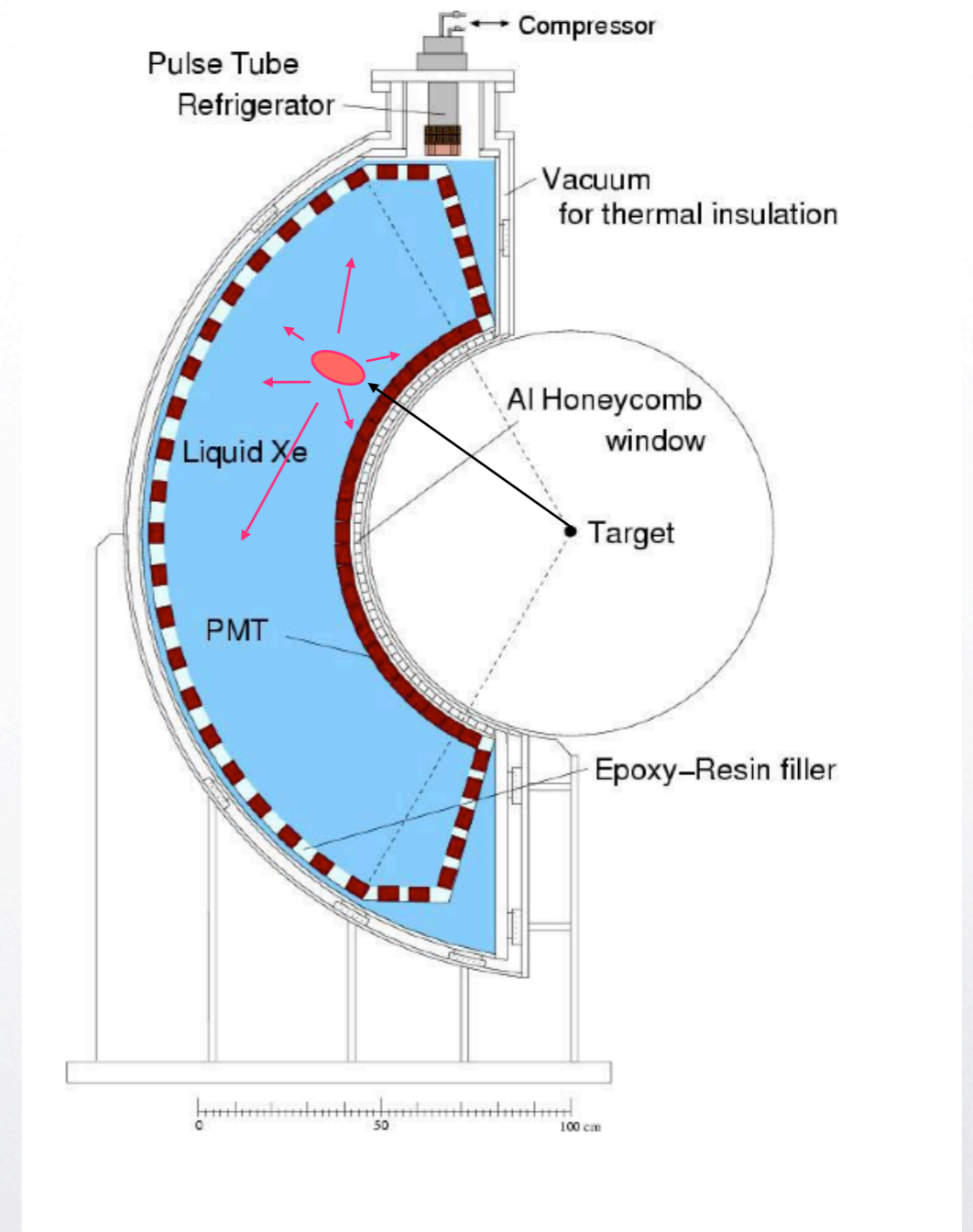
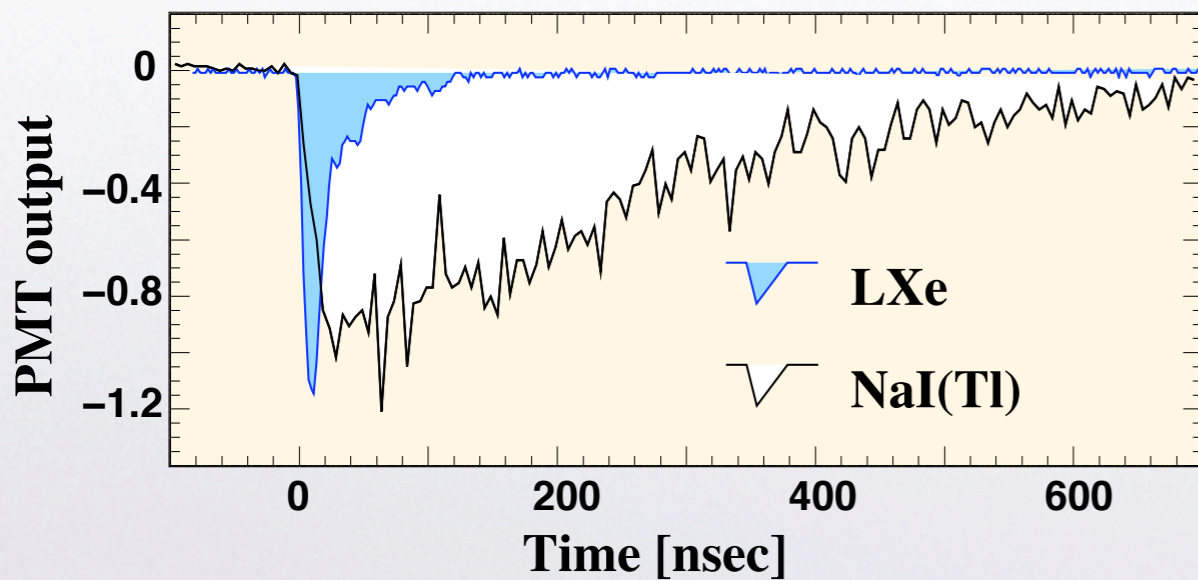



We will take waveforms to reject pileups.

- We developed waveform digitizer (Domino ring sampler).
- Variable sampling speed up to 4.5 GHz
- 1024 cells per channel. 12bit ADC.
- ~85 \$ per channel.

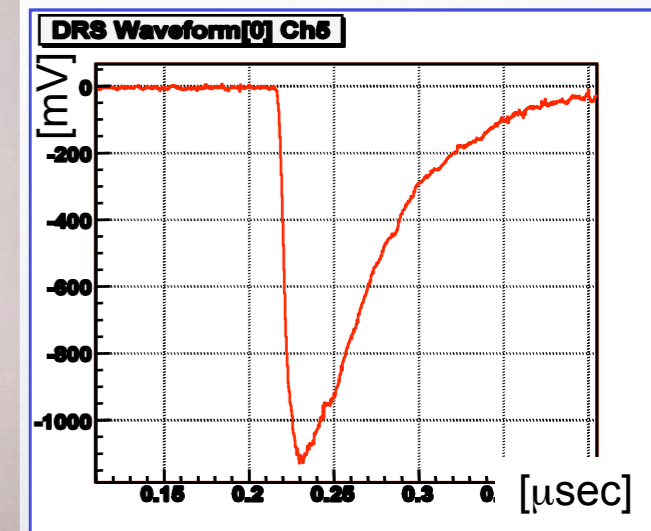
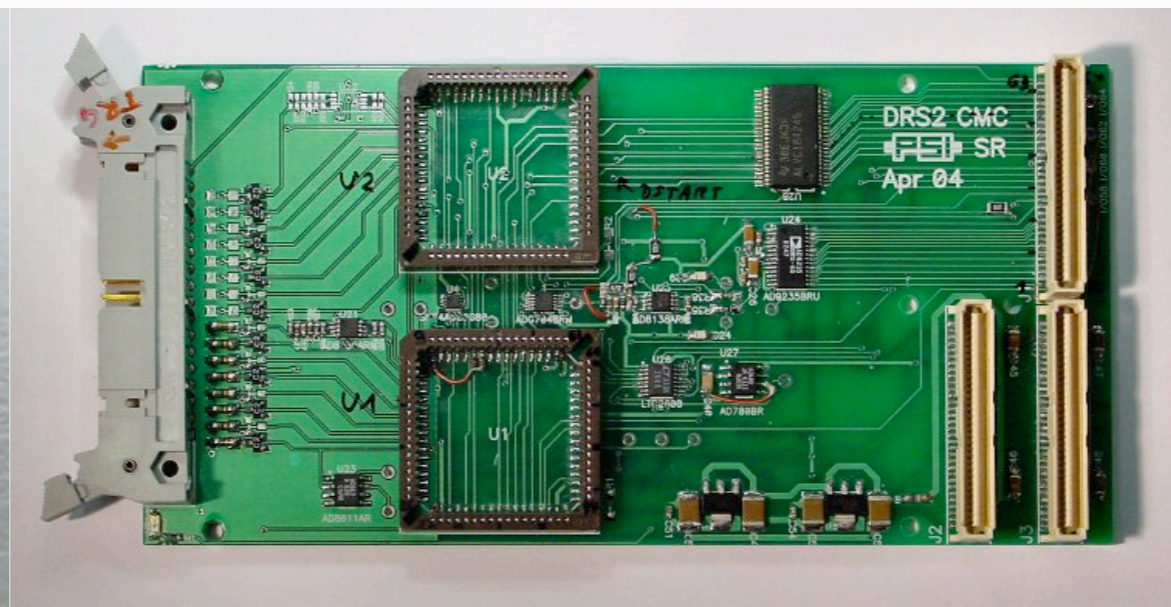
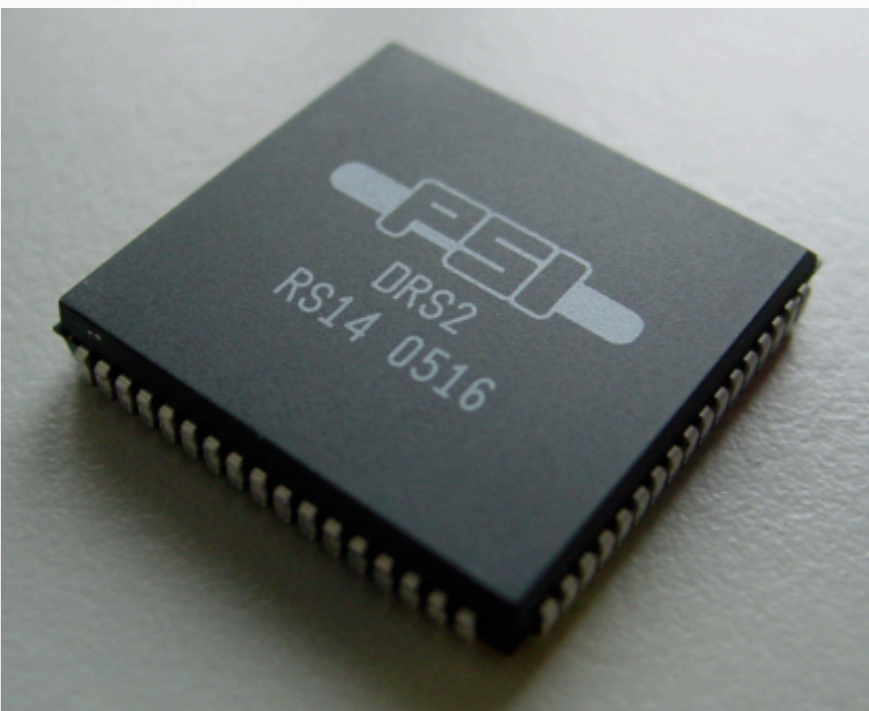



Under construction.

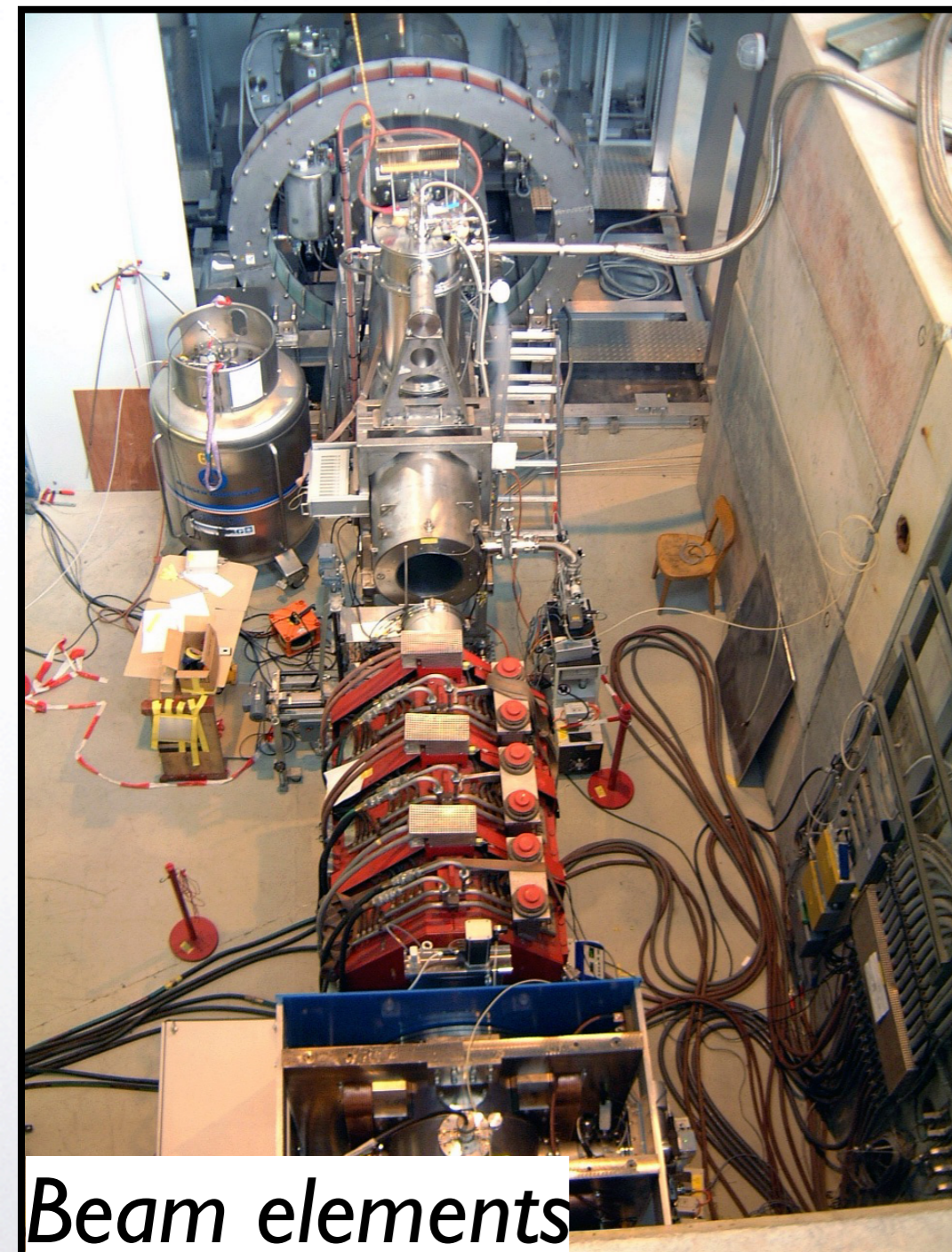
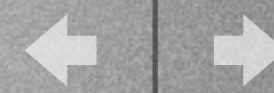

Beam elements



Drift chamber

Testing 800 PMTs

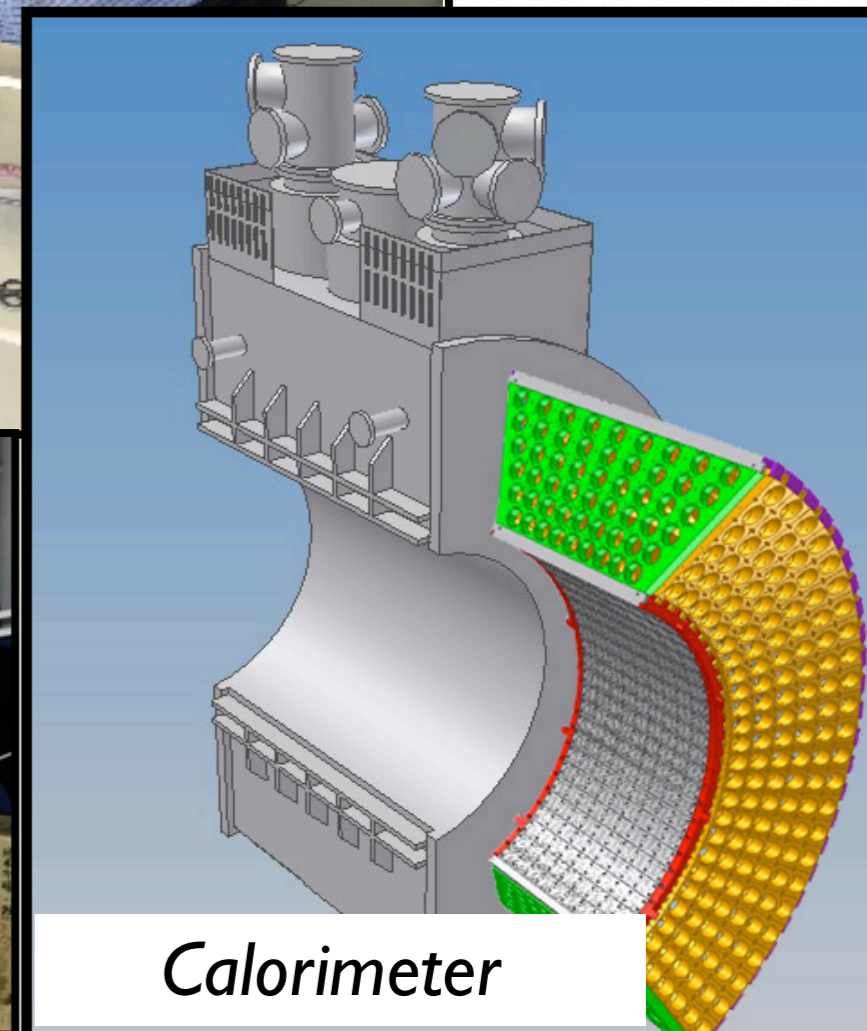

Calorimeter



R&D of Liquid Xe Calorimeter



Prototype



- $\sim 1/10$ fiducial volume of the final detector (already the world's biggest Xenon detector.)
- Same thickness as the final detector to observe 52.8 MeV gamma ray.
- Tested with 10, 20, 40, 55, 83 and 129 MeV gamma ray.

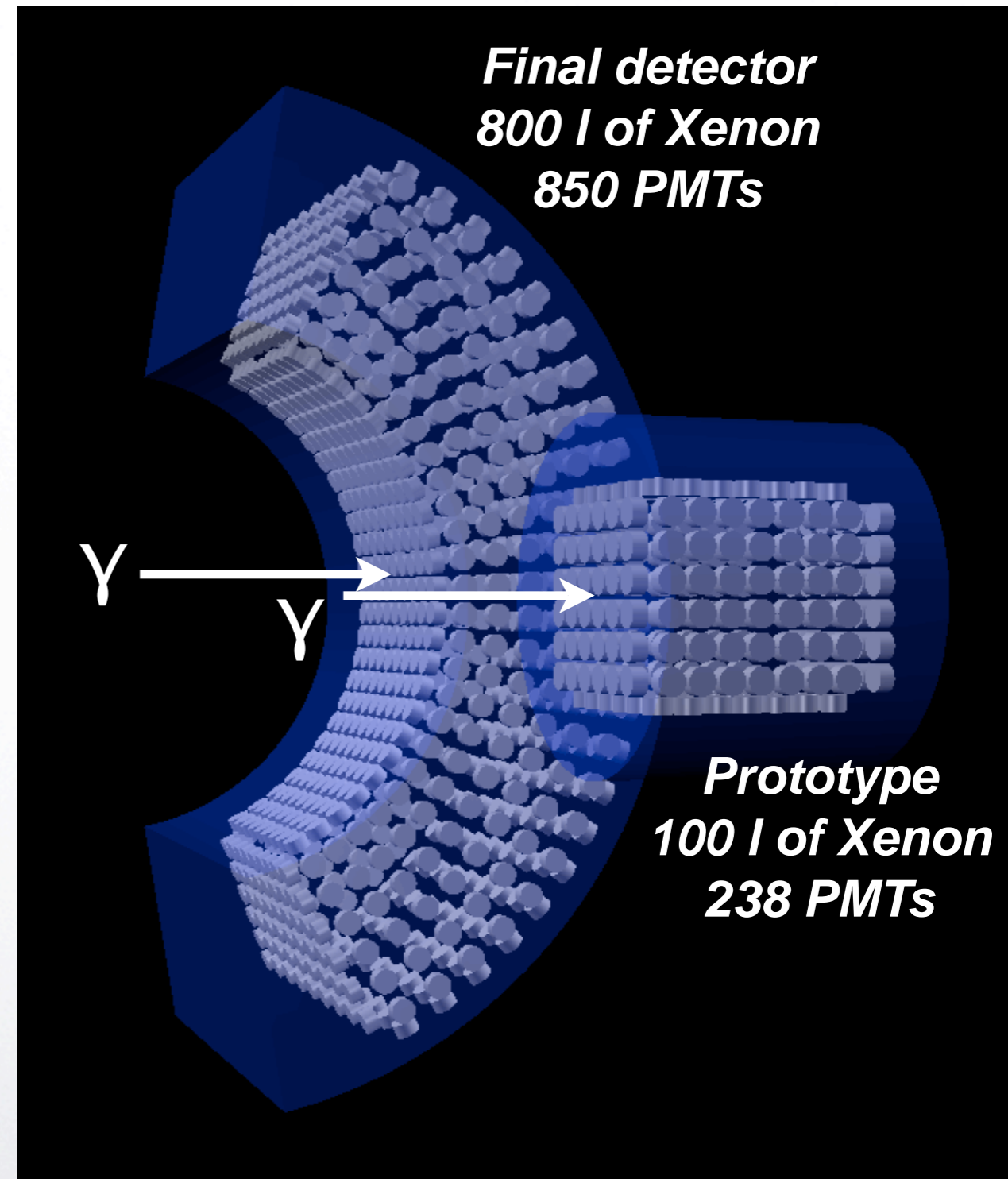
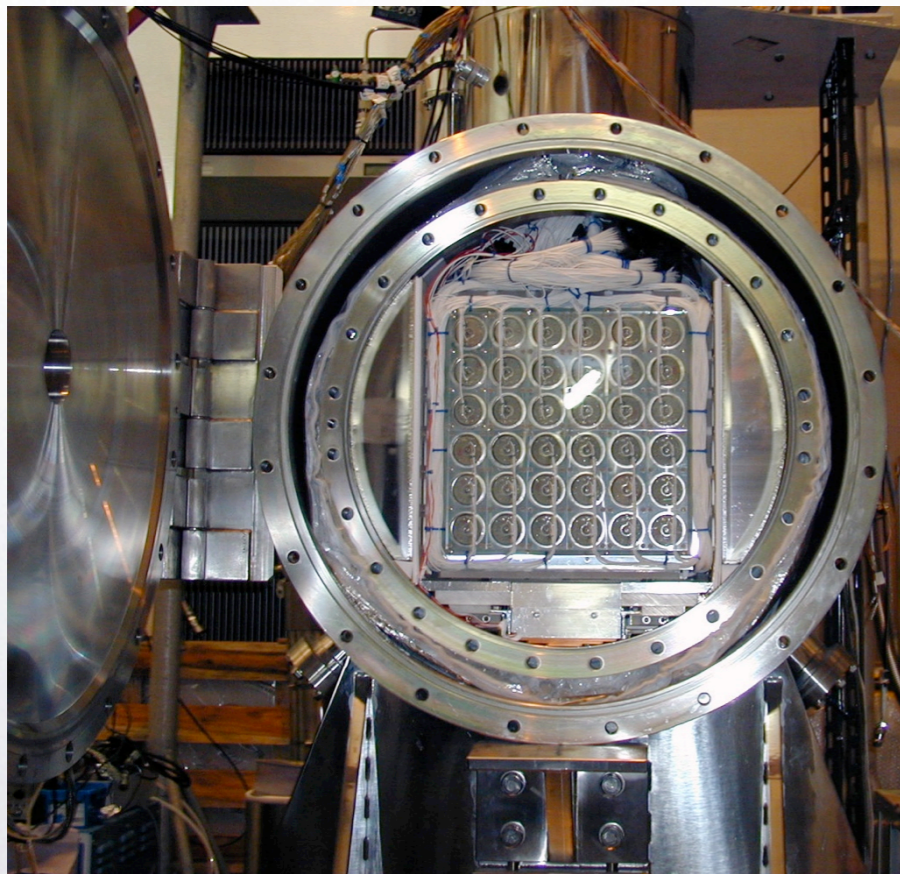



Prototype cont'd



What was done with prototype

1. Cooling technology 250 ppb
2. Xenon purification technique
3. Improvement of PMT (Q.E. and rate dependence)
4. Calibration method 40 ppb
5. Measurement of optical property (attenuation.)
6. Development of reconstruction algorithm.
7. Measurement of resolution of the detector.

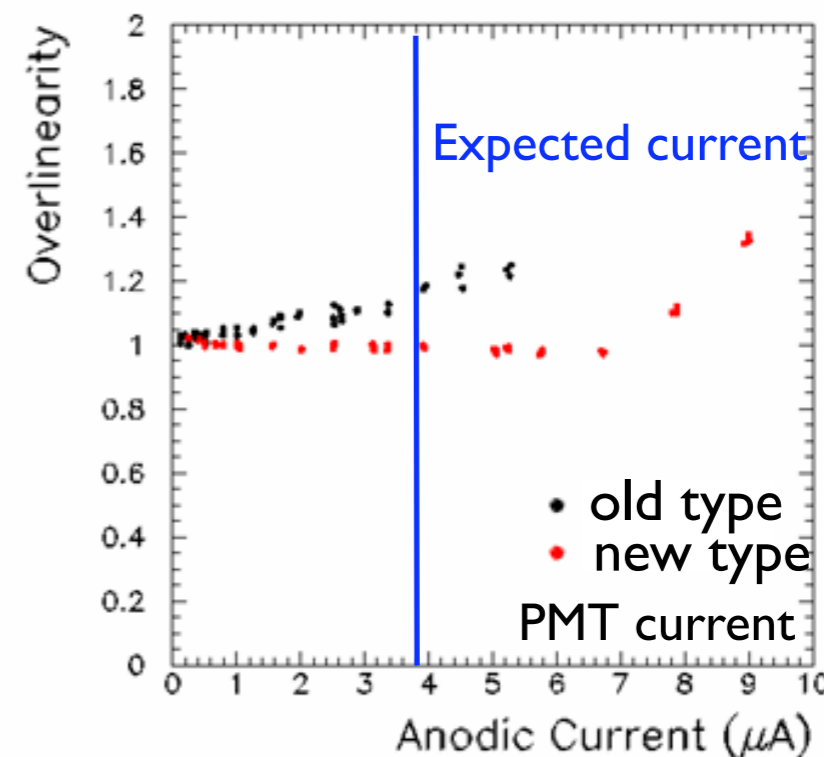
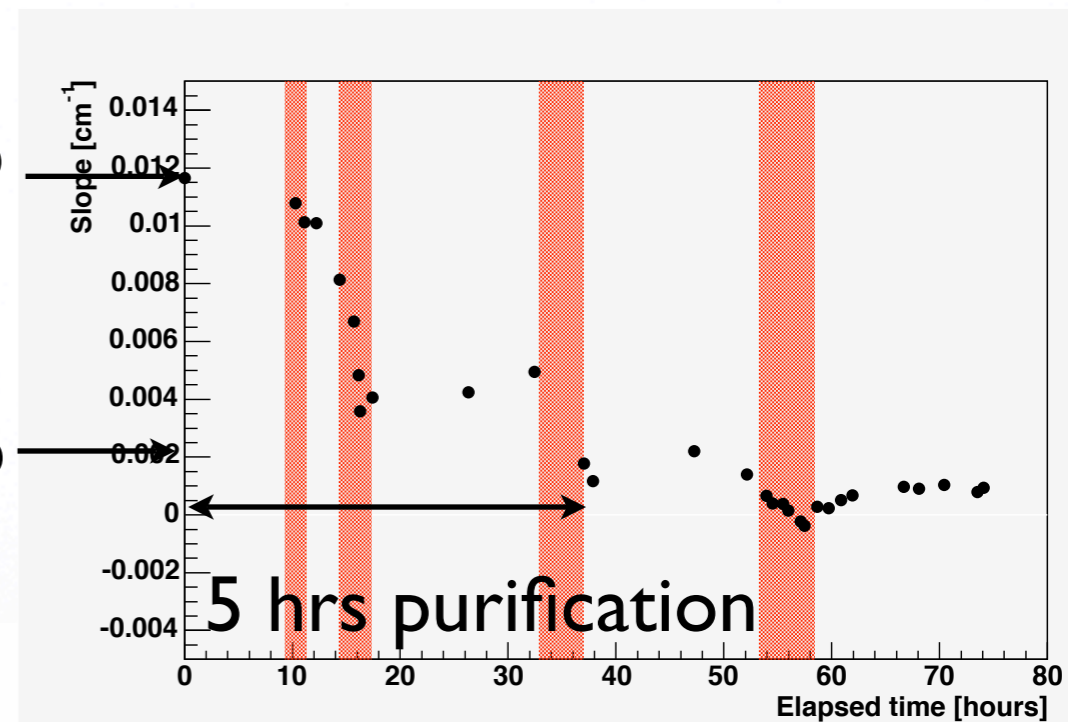



Two beam tests



Two beam tests were done to test the detector response.

1. Gamma rays with 10, 20 and 40 MeV Compton edge from laser Compton scattering.
2. 55, 83 and 129 MeV gamma rays from pion decay.

LCS beam test

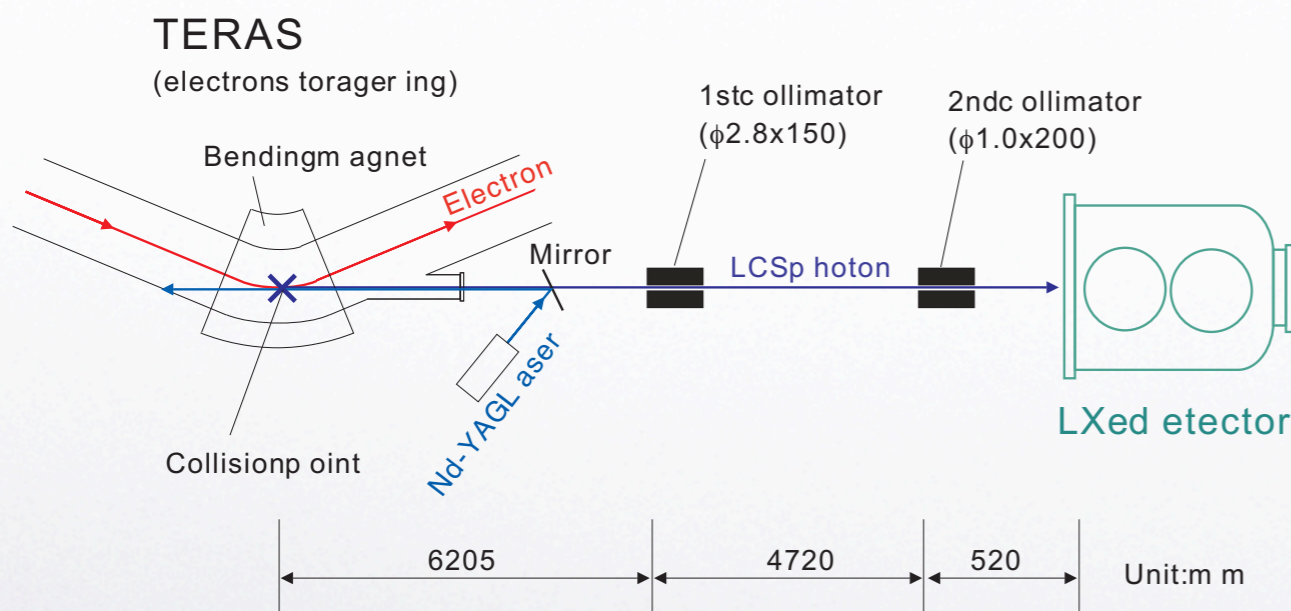

Backward laser Compton scattering.
 Measured resolution using Compton edge.

CEX beam test

$$\pi p \rightarrow \pi^0 n$$

$$\pi^0(28\text{MeV}/c) \rightarrow \gamma \gamma$$

$$54.9 \text{ MeV} < E(\gamma) < 82.9 \text{ MeV}$$

- Requiring $\theta > 175^\circ$
FWHM = 0.3 MeV

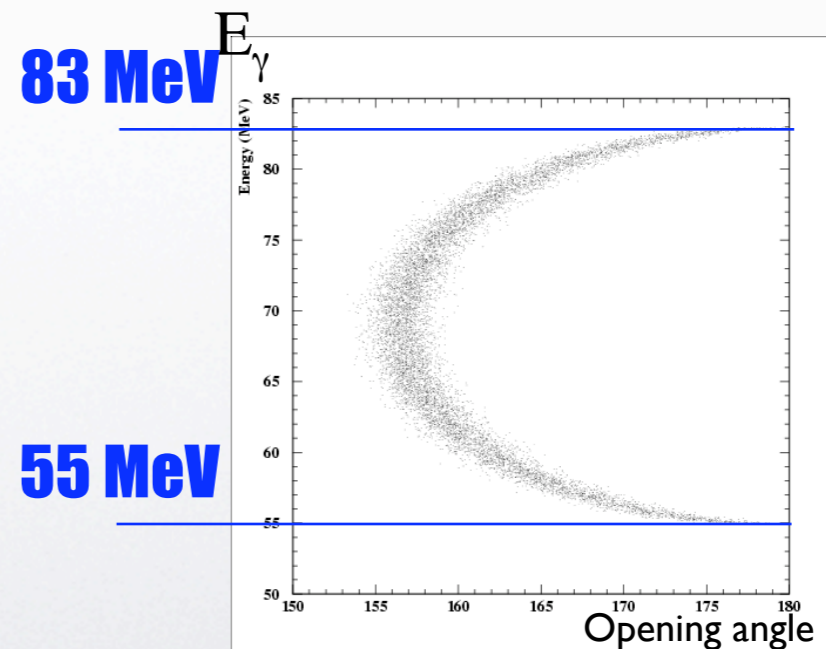

monochromatic gamma rays from pion decay



Prototype - Energy Resolution

Energy resolutions were measured in both LCS and CEX test.

Good resolution of upper part of spectrum is important.

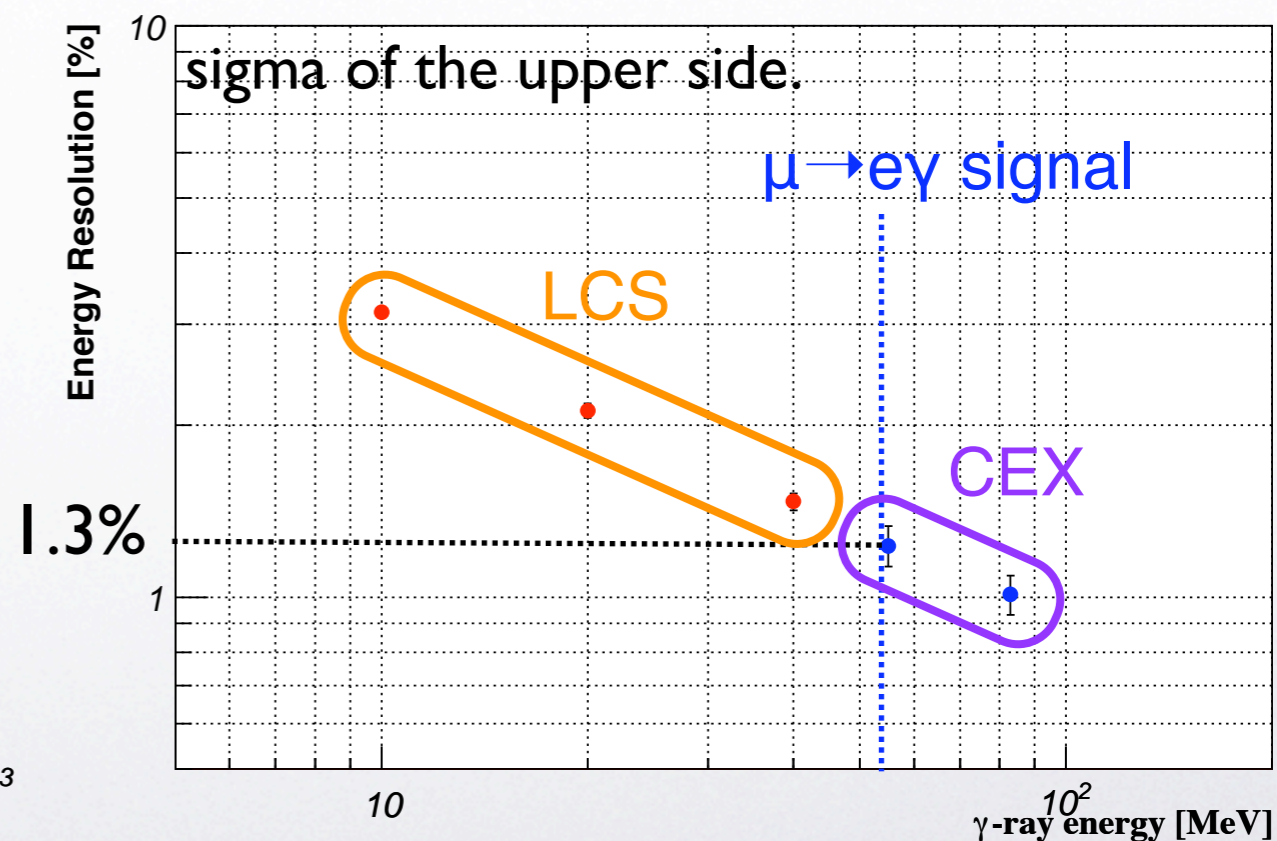
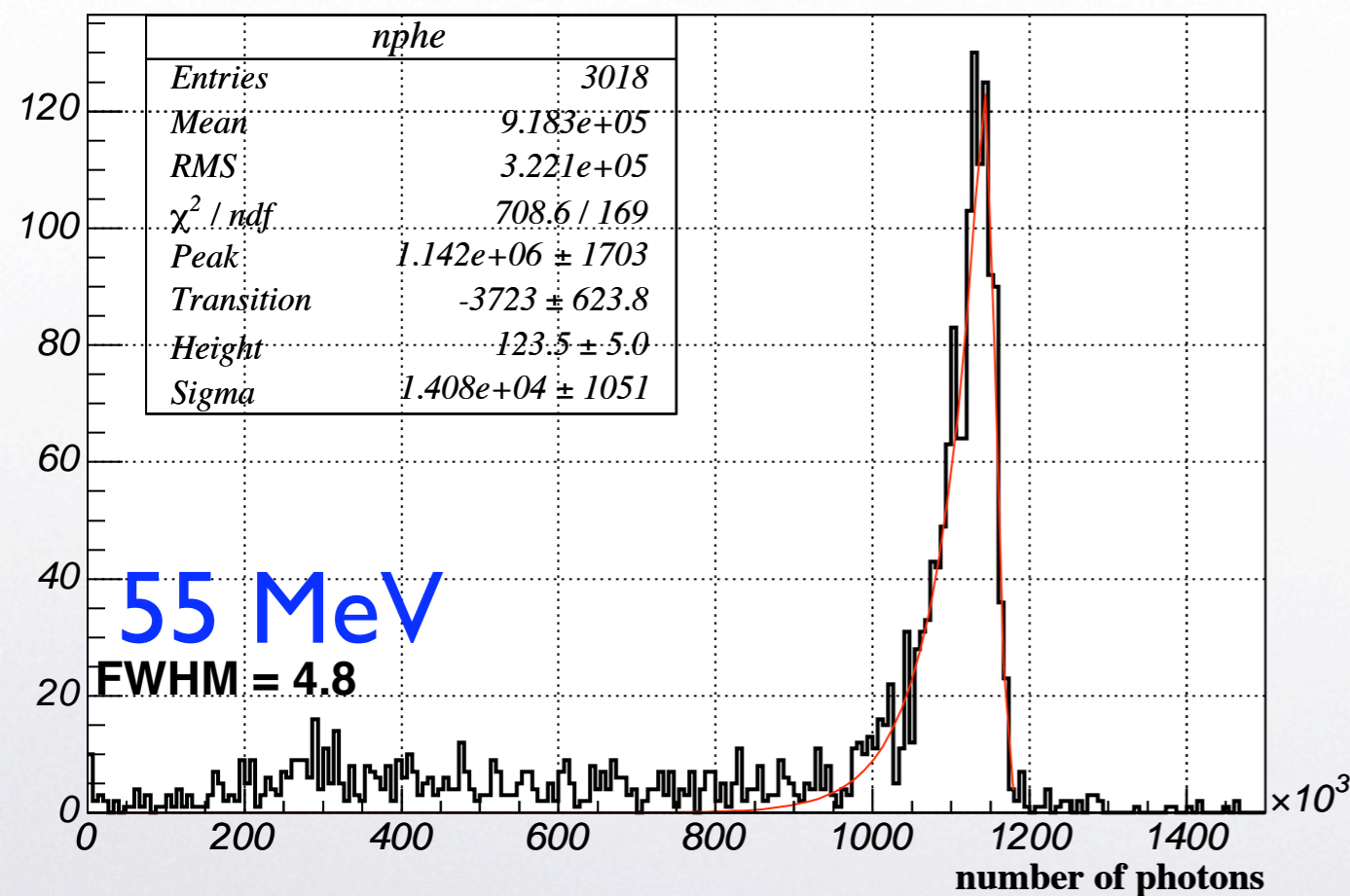



Prototype - Position Resolution

- Position resolution was measured by using collimated LCS gamma beam.
- Beam spot size is small enough to estimate resolution.

impinging points of measurement

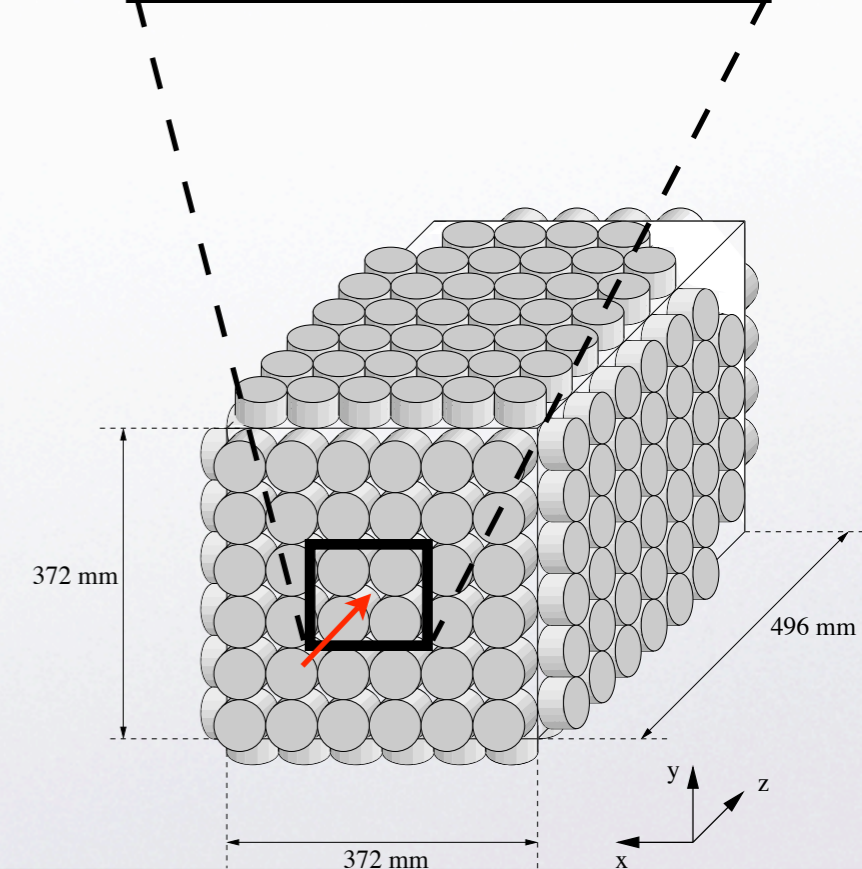
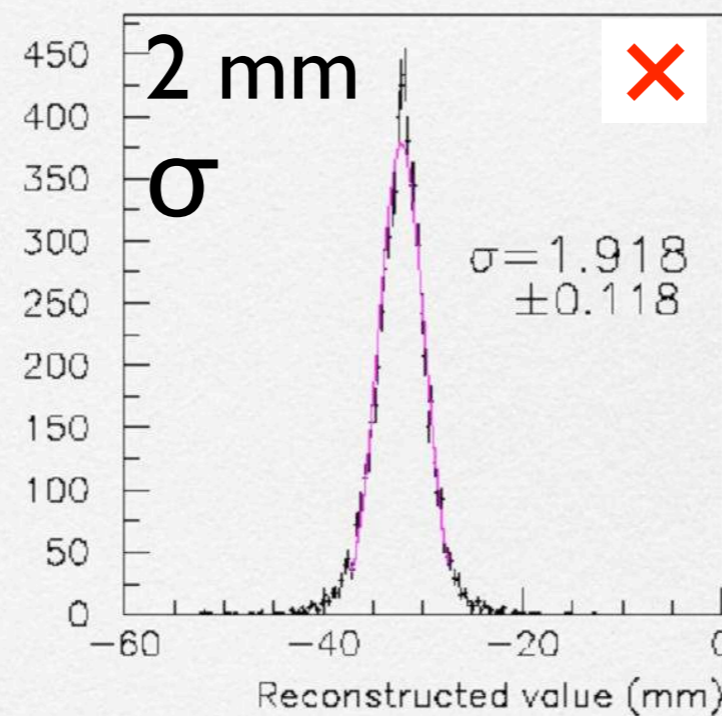
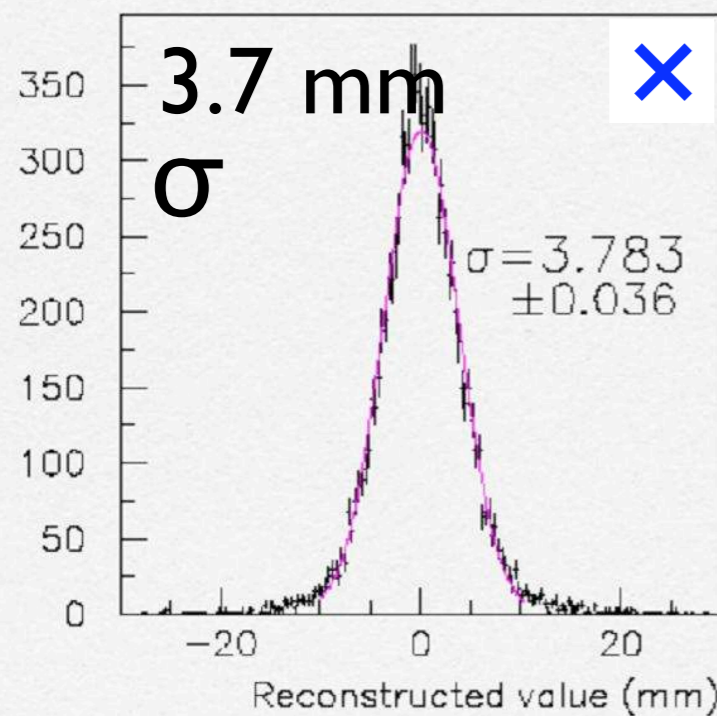
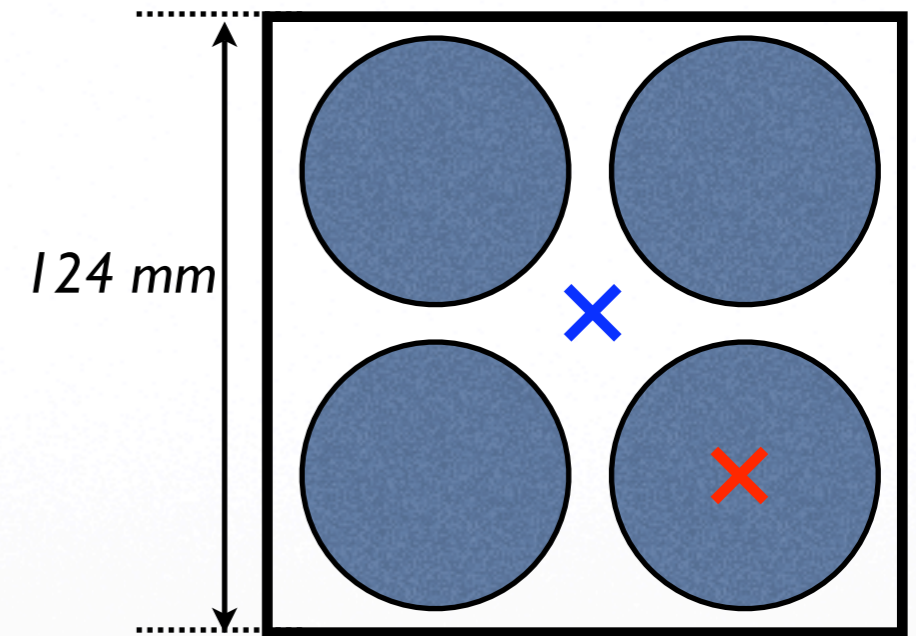



Prototype - Timing Resolution ◀ | ▶

Timing resolution was measured at CEX beam test with measuring two gammas from π^0 decay.

LXe detector

LH2 target

NaI+LYSO

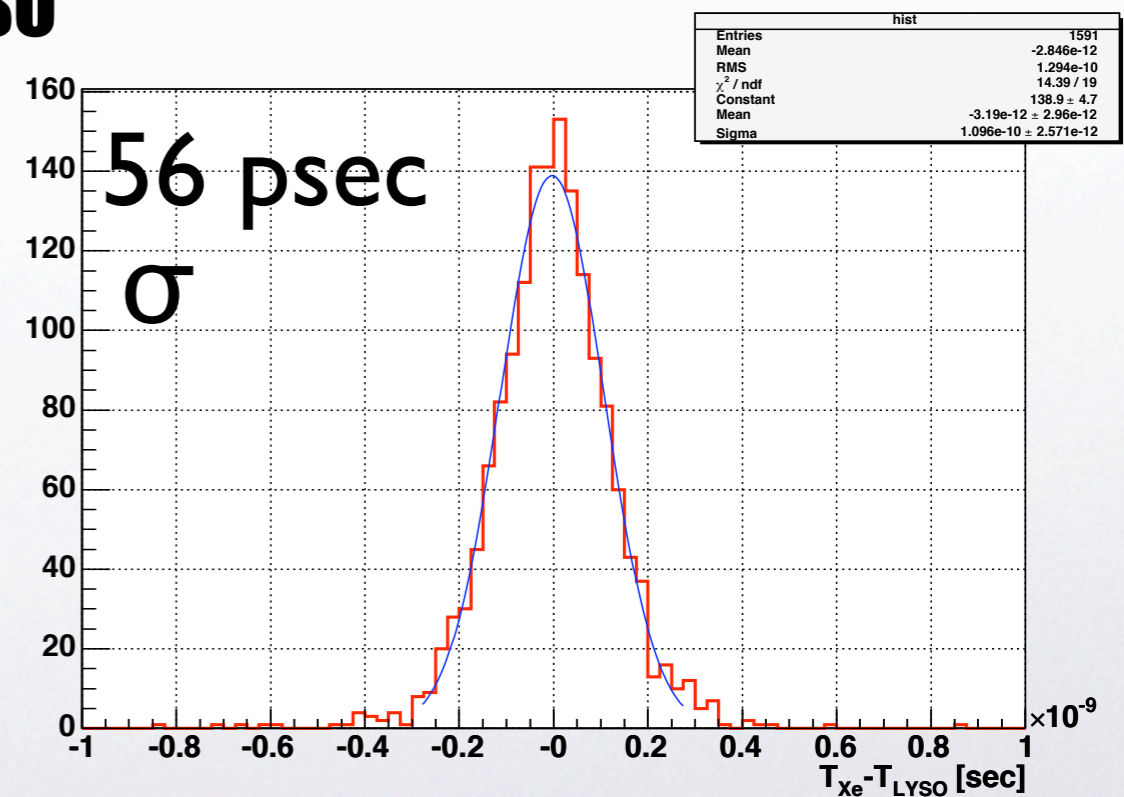
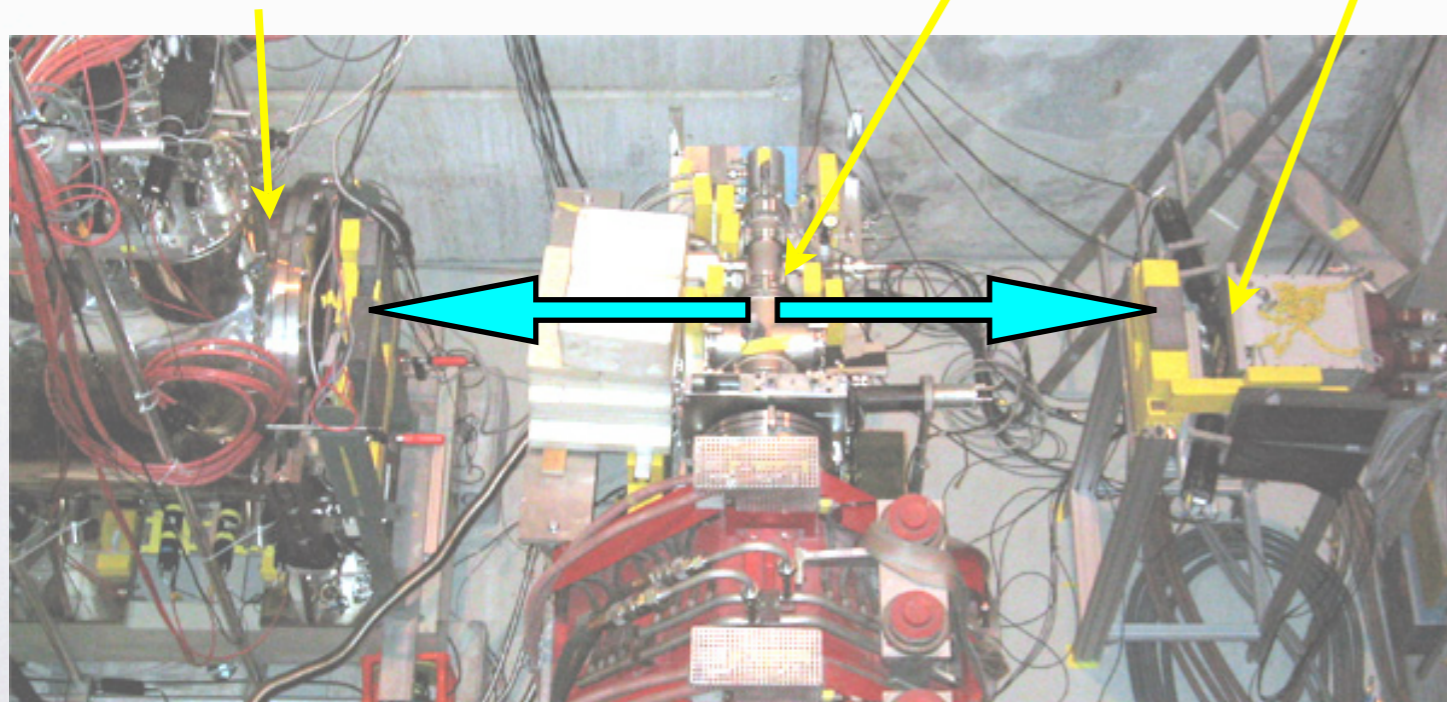



Result of prototype tests



Extrapolated result of prototype to 52.8 MeV gamma ray.

Energy	~ 5%
Position	< 9mm
Time	~150 psec (FWHM)

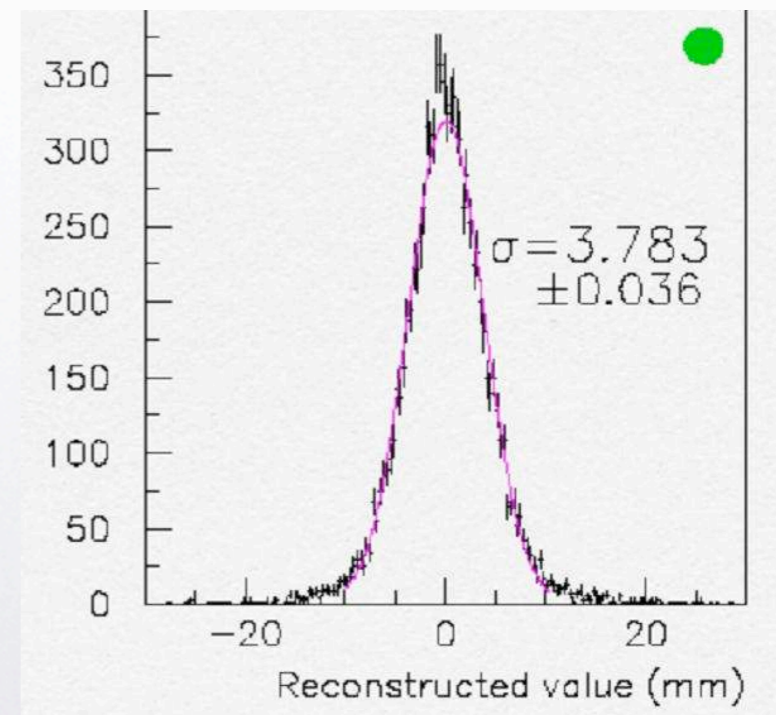
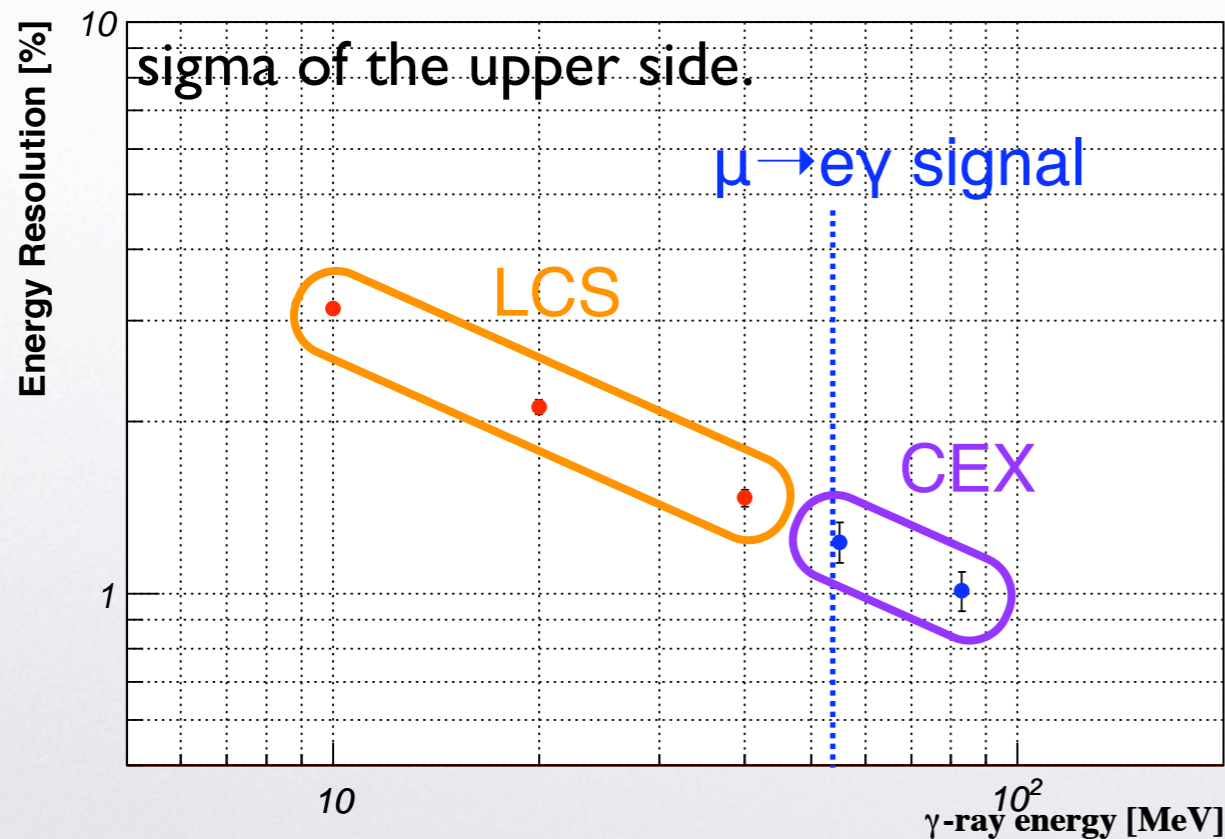
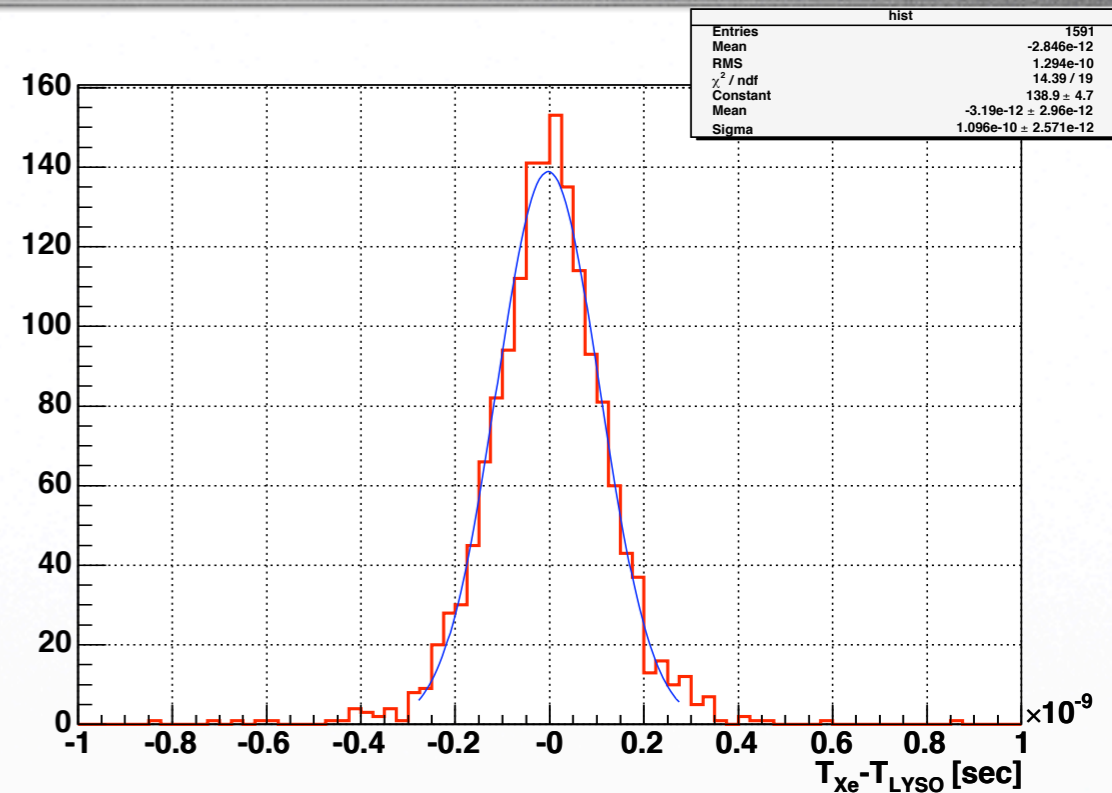



Sensitivity



Detector

Gamma Energy (%)	5.0
e+ Timing (nsec)	0.1
Gamma Timing	0.15
Gamma Position (mm)	9.0
Gamma acceptance	0.4

(FWHM)

Beam

Muon rate ($10^8/\text{sec}$)	0.35
Running Time (10^7sec)	4.0

2 years

Sensitivity

Accidental Rate (10^{-14})	3.0
Number of Accidental Events	0.6
90% CL Limit (10^{-13})	1.4



Summary



- Discovery of $\mu \rightarrow e\gamma$ is a clear evidence of new physics beyond the standard model.
- MEG experiment has sensitivity to observe $\mu \rightarrow e\gamma$ predicted by SUSY.
- The first run of MEG will start in the next year. Currently, the detector is under construction.
- MEG will pioneer the particle physics in 21st Century.



End of talk



Vernier System

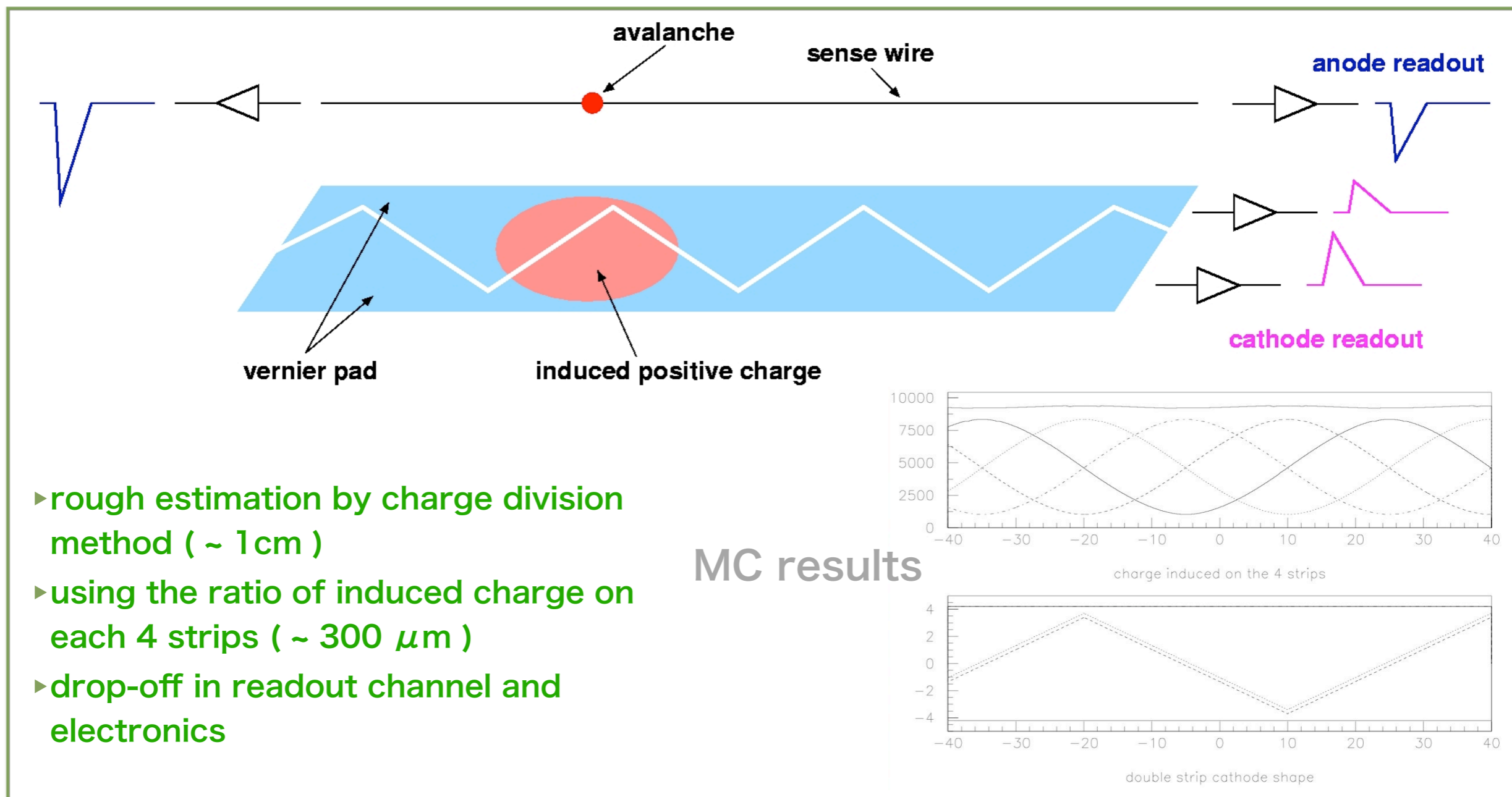

- ▶ rough estimation by charge division method (~ 1cm)
- ▶ using the ratio of induced charge on each 4 strips (~ 300 μm)
- ▶ drop-off in readout channel and electronics



Vertex reconstruction

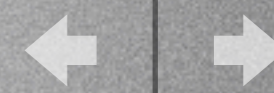

- ▶ trace back (initial muon decay vertex) , ~ 1.2 mm accuracy

